



# VAVA Chroma 4K UST Triple Laser Projector

User Manual

[vava.com](http://vava.com)



# CONTENTS

IMPORTANT SAFETY INSTRUCTIONS	01
KNOWING YOUR PROJECTOR	02
USING YOUR PROJECTOR	09
CLEANING AND MAINTENANCE	25
TROUBLESHOOTING	27



## IMPORTANT SAFETY INSTRUCTIONS

- Danger of explosion if battery is incorrectly replaced. Replace only with the same or equivalent type.
- Disposal of a battery into fire or a hot oven, or mechanically crushing or cutting of a battery, that can result in an explosion.
- Leaving a battery in an extremely high temperature surrounding environment that can result in an explosion or the leakage of flammable liquid or gas.
- A battery subjected to extremely low air pressure that may result in an explosion or the leakage of flammable liquid or gas.
- The operation altitude is up to 2500m.

### 1. ABOUT LASER LIGHT

- Never look into the projector lens when the laser is turned on; this can result in eye damage.
- Do not try to dismantle the projector. It contains a high-power laser component; attempting to modify can result in serious injury.
- Do not allow children to operate the projector. They must be accompanied by an adult for use.

### 2. HIGH TEMPERATURE

- Do not place anything that can become warped or damaged by heat near the vents.
- Do not bring your hands or face close to the vents while projection is in progress.
- Do not place flammable materials such as aerosols near the device in case of fire.

**FOR HOUSEHOLD USE ONLY**  
**READ AND SAVE THESE INSTRUCTIONS**



# KNOWING YOUR PROJECTOR



## 1.1 Package Contents

VAVA Chroma	*1
Remote Control	*1
AAA Battery	*2
59-inch Power Cord	*1
Cleaning Cloth	*1
User Manual	*1
Quick Start Guide	*1

## 1.2 Parts and Components

### PROJECTOR

#### Front/Top

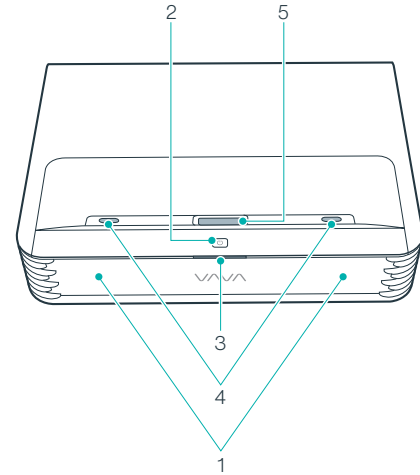

- 1. Speaker
- 2. Power Button
- 3. Status Indicator

- 4. PIR Sensor
- 5. Lens

Blinking	Booting/Shutting down
Off	Outage/Abnormal
Solid On	Powered but not on

## Side

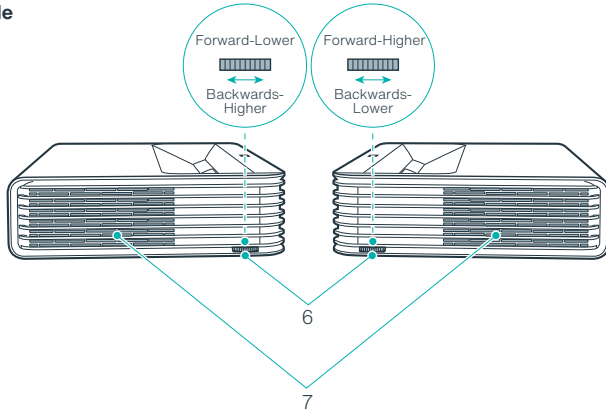

6. Height Adjusting Wheels

7. Heat Dissipation Vents

## Rear/Bottom

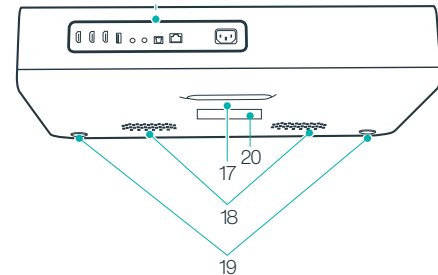

- 8. HDMI Input 1
- 9. HDMI Input 2
- 10. HDMI 3 ARC
- 11. USB Port
- 12. Audio Output
- 13. AV Input
- 14. S/PDIF Port
- 15. Ethernet Port
- 16. Power Port
- 17. Rear Foot
- 18. Speaker Air Vents
- 19. Front Foot \*2
- 20. Product Nameplate

## REMOTE CONTROL

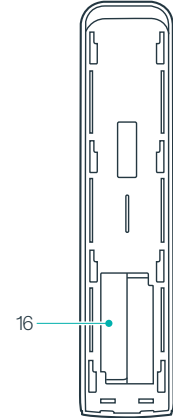
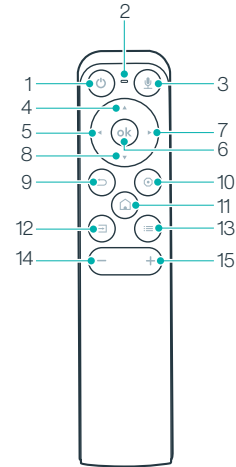

- 1. Power
- 2. Mic
- 3. Voice Assistant
- 4. Up
- 5. Left
- 6. OK
- 7. Right
- 8. Down
- 9. Return
- 10. Settings
- 11. Home
- 12. Signal
- 13. Menu
- 14. Volume -
- 15. Volume +
- 16. AAA Battery Holder

## 1.3 Specifications

Projection System	
Display Type	DLP
Light Source	RGB-Laser
Throw Rate	0.233
Projection Size	Up to 150"
Resolution	4K
Brightness	2500 lumen (100% CLO) / 6000 lumen (Light Source)
Luminance Uniformity	> 80%
Contrast Ratio	> 300:1 (ANSI) / > 3000:1 (FOFO)
Color Gamut	106% Rec.2020
Smart TV System	
System	Android 9.0
App Store	VAVA Store
ROM	32GB
RAM	3GB
Motion Detection	Yes
HDR 10	Yes
HLG	Yes
Keystone Correction	Yes (8 Points)
Electric Focus	Yes
Built-in Alexa	Yes

Audio	
Speaker	Harman / Kardon, 60W (total)
Bluetooth In	Yes (connect with mobile phone)
Bluetooth Out	Yes (connect with Bluetooth speaker)
DTS-HD	Yes
Dolby Audio	Yes
Interface	
HDMI	3 ports (HDCP2.2, 1 with ARC)
USB	1 (5V DC, 500mA)
Video In	AV3.5
Audio Out	Line out 1 (3.5mm) and S/PDIF 1
RJ45	1
Connectivity	
Internet	Wired and wireless (802.11ac 2.4G / 5G 2T2R, with DFS)
Bluetooth	BT5.0
Power	
Input	100-240V AC, 50/60Hz, 4A
Power Consumption	≤360W
Standby Power Consumption	<0.5W
Others	
Projection Method	Desktop projection/Ceiling mounted projection
Dimensions	542*378*117.4mm/21.34*14.88*4.62 inch
Weight	10.65kg/375.67oz
Noise	<30dB
Working Temperature	0 - 40°C / 32 - 104°F
Storage Temperature	-20 - 65°C / -4 - 149°F



# USING YOUR PROJECTOR

# 2

## 2.1 Quick Installation Guide

### PREPARATION

Install the electrical outlet near the equipment. It should be easily accessible. Take the 4 following items into consideration when installing the projector:

- 1) Distance between the projector back and the wall (W1)
- 2) Height: image width (height) (H1), height between the bottom of the image and the desk (H2), height of the desk (H3), and the recommended height of the wall (H4)
- 3) Surface for placing the projector

You can place the projector on almost any sturdy, flat and level surface, to project an image.

Dimensions of the desk:

- Mobile desk: W2, H3, and L2
  - Immobile desk: W2, H3, L2 and W1 (leave enough space to move the device on the desk)
- 4) Image of the projection

The wall for the projection should be larger than the area of your desired image size.

Wall area: length (L3,  $\geq L1$ ) x width (H4,  $\geq H1 + H2 + H3$ ) in the diagram.

## Parameters for Projection (100" for example)

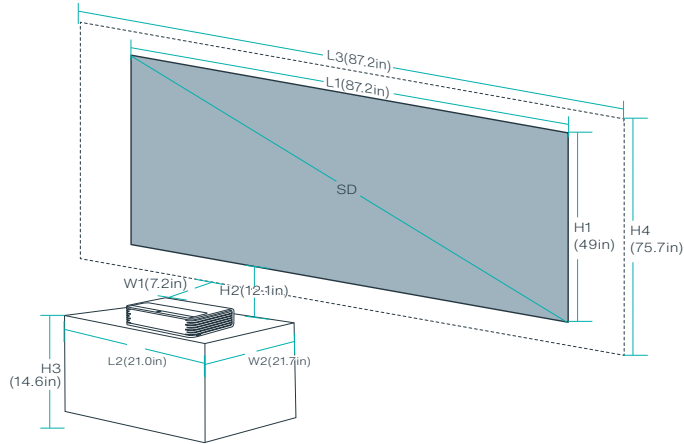

Image SD	Desk Length (L2)	Desk Width (W2)		Desk Height (H3)	Wall Length (L3)	Wall Width (H4)
	$L2 \geq L$	Mobile Desk: (W2 $\geq$ W)	Immobile Desk: (W2 $\geq$ W+W1)	Image center at 1.3m high	$L3 \geq L1$	$H4 \geq H1+H2+H3$
80"			$\geq 45.3\text{cm}$ / 17.8in	53.9cm / 21.2in	$\geq 177.1\text{cm}$ / 69.7in	$\geq 179.8\text{cm}$ / 70.8in
90"			$\geq 50.2\text{cm}$ / 19.8in	45.4cm / 17.9in	$\geq 199.3\text{cm}$ / 78.5in	$\geq 186.5\text{cm}$ / 73.4in
100"	$\geq 53.3\text{cm}$ / 21.0in	$\geq 36.8\text{cm}$ / 14.5in	$\geq 55\text{cm}$ / 21.7in	37.0cm / 14.6in	$\geq 221.4\text{cm}$ / 87.2in	$\geq 192.3\text{cm}$ / 75.7in
120"			$\geq 64.6\text{cm}$ / 25.4in	20.1cm / 7.9in	$\geq 265.7\text{cm}$ / 104.6in	$\geq 204.7\text{cm}$ / 80.6in
150"			$\geq 79.2\text{cm}$ / 31.2in	0cm / 0in	$\geq 332.1\text{cm}$ / 130.7in	$\geq 228.7\text{cm}$ / 90.0in

## Projection Distance & Image Dimensions

Device Dimensions (LxWxH)	Image SD	Image Length (L1)	Image Width (H1)	Device-Wall Distance (W1)	Image-Desk Height Gap (H2)
53.3 x 36.8 x 10.7cm / 21.0 x 14.5 x 4.2in	80"	177.1cm / 69.7in	99.6cm / 39.2in	8.5cm / 3.3in	26.3cm / 10.4in
	90"	199.3cm / 78.5in	112.1cm / 44.1in	13.4cm / 5.3in	28.6cm / 11.3in
	100"	221.4cm / 87.2in	124.5cm / 49.0in	18.2cm / 7.2in	30.8cm / 12.1in
	120"	265.7cm / 104.6in	149.4cm / 58.8in	27.9cm / 11.0in	35.2cm / 13.9in
	150"	332.1cm / 130.7in	186.8cm / 73.5in	42.4cm / 16.7in	41.9cm / 16.5in

## Example Calculation for a 100" Image

- Distance (W1): 18.2cm / 7.2in.
- Heights: H1: 124.5cm / 49.0in; H2: 30.8cm / 12.1in; H3: 37.0cm / 14.6in (thus the image center is at 1.3m / 51.2in high, suitable for audience sitting on a sofa in front); H4:  $\geq 192.3\text{cm}$  / 75.7in.
- Area of the desk (L2 x W2):  $\geq 53.3 \times 55\text{cm}$  / 21.0 x 21.7in.
- Area of the wall (L3 x H4):  $\geq 221.4 \times 192.3 \text{ cm}$  / 87.2 x 75.7in.



## Tips:

- 1) Conversion figures may have been rounded up or down.
- 2) Leave plenty of space around and under the projector for ventilation, and keep the vents unblocked in all directions.
- 3) Position the projector within reach of a grounded electrical outlet or extension cord.
- 4) The projected image size increases as the projector is placed farther from the wall. Move the desk for placing the projector as the distance requires.
- 5) For H3, the provided recommended value of the image center at 1.3 m./51.2 in. high would be most comfortable with the assumption that it will be viewed from a sofa. You can adjust per your personal preference.

## INSTALLING THE PROJECTOR

Place the projector on the desk. Move to an appropriate distance for the desired image size while keeping the device parallel with the wall. Connect the projector to a power source and press the Power button on the device or remote to turn it on. Follow the instructions to go through the wizard, including the following operations:

- 1) Choose a language
- 2) Pair with the remote control
- 3) Network settings
- 4) Adjust the projection area
- 5) Select the time zone

## 2.2 Functions

### 1. MOTION DETECTION

There are two PIR motion sensors at the front of the projector; when it detects human approaching, the projector will dim the brightness of the laser light to prevent any potential eye damage. This function is active by default and can be disabled in Settings -> General. Press any button on the remote control and the laser light will restore to normal brightness level.

### 2. HDR10

This projector supports HDR10, currently the most widely used High Dynamic Range technology, especially for Blu-ray devices and professional game consoles. Compared to devices without HDR10, the projector delivers images with more detail and a wider dynamic range.

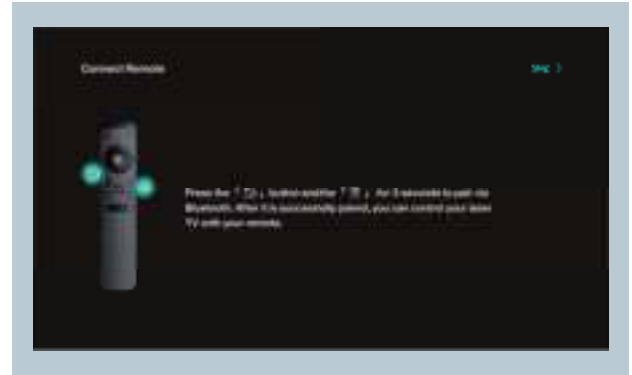

### 3. DOLBY AUDIO AND DTS DECODING

The projector supports Dolby Audio and DTS (dedicated to sound) decoding, perfect for a home theater.

- 1) Manufactured under license from Dolby Laboratories. Dolby, Dolby Audio and the double-D symbol are trademarks of Dolby Laboratories.
- 2) For DTS patents, see <http://patents.dts.com>. Manufactured under license from DTS Licensing Limited. DTS, the Symbol, DTS and the Symbol together, DTS-HD, and the DTS-HD logo are registered trademarks and/or trademarks of DTS, Inc. in the United States and/or other countries. ©DTS, Inc. All Rights Reserved.

### 4. TEMPERATURE PROTECTION

The built-in temperature protection function can protect the device in the case of a high ambient temperature. The projector will prompt a warning message and enter ECO mode automatically when the ambient temperature is higher than 100°F. If the temperature reaches 109°F, the device will activate the function of protection against abnormalities and shut off.

## 2.3 Operation Guide

### 1. POWER ON/OFF

Connect the projector to a power source. Press the Power button on the projector or the remote to power it on / off.

### 2. POSITION ADJUSTMENT

Refer to the following instructions to adjust the position of the projector and get an undistorted image.

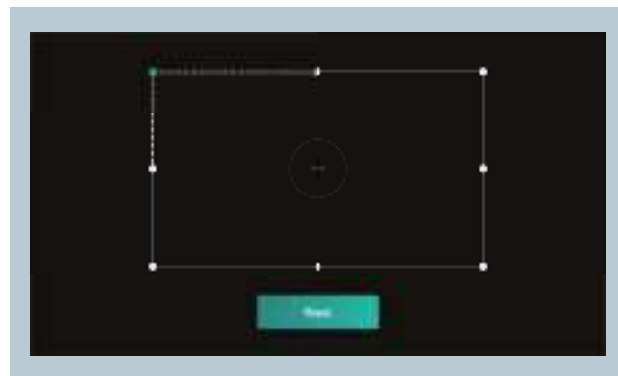

### 3. USER INTERFACE OVERVIEW

There are 2 parts on the homepage: Inputs and Tools.

- Signal source: HDMI1, HDMI2, HDMI3 & AV
- Tools: File Manager, App Manager, Local Application, Setting and Help.

On top you can see the Network, Bluetooth, and the time.

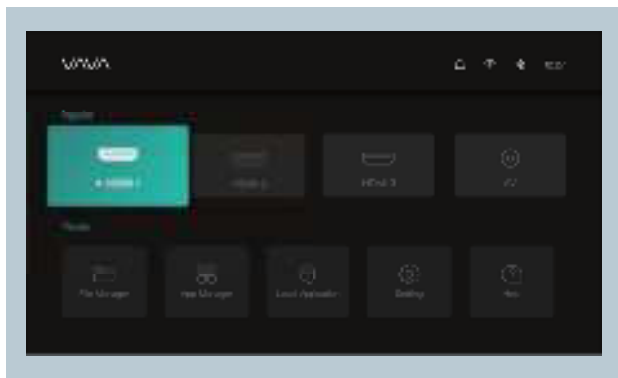

### 4. CONNECTION WITH PERIPHERALS

You may connect PS4 game console, ROKU TV, computer, etc., via the HDMI port, DVD device by the AV port, USB device/keyboard/mouse by the USB port (refer to 5. File Management), or professional audio by S/PDIF or LINE OUT port.

- 1) Choose the corresponding signal source for the device connected, including HDMI1, HDMI2, HDMI3, and AV.
- 2) Select audio output on the homepage, go to Settings -> Audio, and select the corresponding output method among the following options in Audio Output.
  - Speaker: Use the built-in speaker
  - Headphone: Connect to headphones
  - S/PDIF: Connect to external audio device by S/PDIF port
  - PCM: All formats will be converted to PCM for output.

RAW: No processing for the source audio. Recommended for Dolby Audio and DTS sources for better performance.

- HDMI ARC: Output the sound via the HDMI ARC port

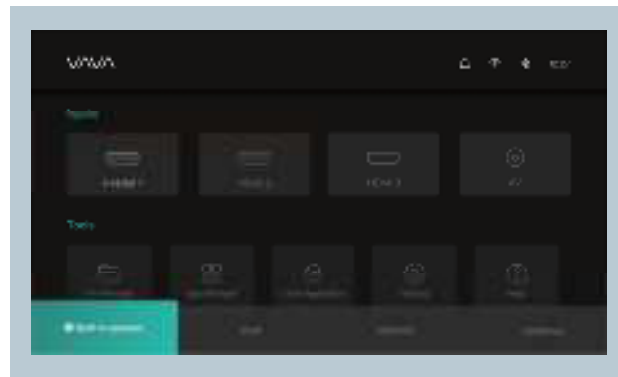

### 5. FILE MANAGEMENT

In File Manager, you can manage the files in the internal flash drive and the plugged USB drive.

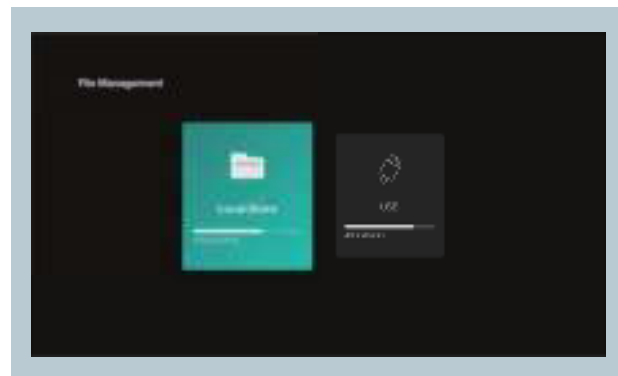

## 1) Internal Flash

You can save files to the projector storage, including the apps downloaded, files downloaded in the app, files in the USB drive, etc.

## 2) Using the USB drive

Plug in the USB drive and view files on the interface.

### Tips:

Support saving, viewing, copying, and deleting files through the All Files folder under these circumstances.

## 6. SEARCHING FOR / INSTALLING / DELETING APPS

The device comes equipped with the Android 9.0 system and the application store. It supports downloading and installation of over 300 apps. Search through, download, and install apps in the Application market.

To delete an app, select the app on the local application, hold down the OK button and select OK on the pop-up window.

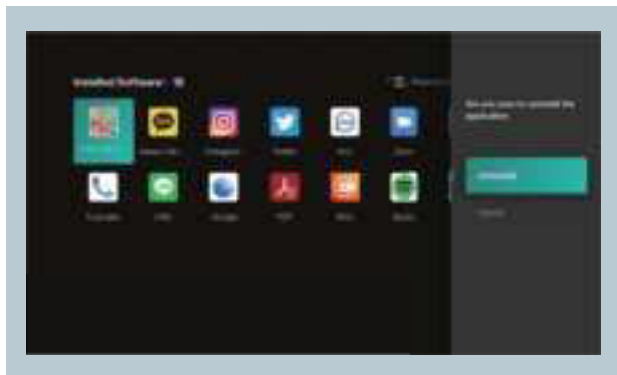

## 7. PAIRING VIA BLUETOOTH

Select the Bluetooth icon at the top right corner to enter the Bluetooth interface.

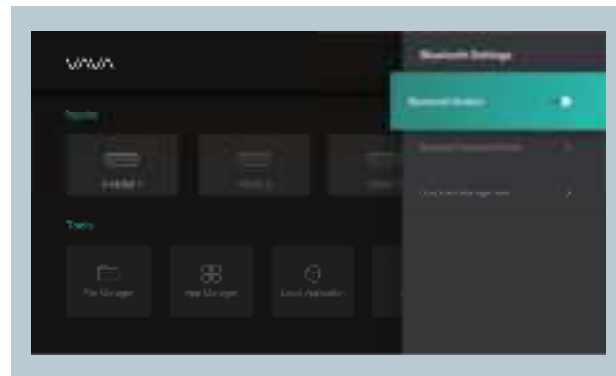

### 1) Use as Bluetooth speaker

Turn on Open Detection, select Input for Audio Mode on the interface, find and select the projector model under Bluetooth Devices on your phone or laptop to play audio via the built-in speaker of the projector (go to Settings -> General -> Device Name to check the Bluetooth name of the projector).

### 2) Pairing with audio devices

Select Output for Audio Mode on the interface, select Search Devices, find and select your audio device under Searched Devices, and the pairing will start automatically. The paired Bluetooth device will appear under Paired Devices.

### 3) Pairing with other devices

To pair with a Bluetooth controller, keyboard, mouse, remote, etc., select Search Devices, then select the desired device under Searched Devices to pair.

### Tips:

To disconnect with a device, select it in My Devices and choose the "Disconnect" option.

## 8. NETWORK SETTING

Select the Network icon at the top right corner to enter the network setting interface.

For wired connection, plug in the Ethernet cable. For wireless connection, find the network name on the drop-down list, select, and enter the password to connect. The software supports network anomaly detection.

- 1) Show Password cannot be selected when the keyboard is shown. Press the Return button to exit the keyboard and tick the box.
- 2) After entering the password, select the Confirm key to connect.



## 9. SYSTEM UPGRADE

OTA update

Select Settings -> About -> Check for Updates to update the system.



## 10. IMAGE SETTINGS

Go to Settings -> Image, or press the Settings button to enter the interface.

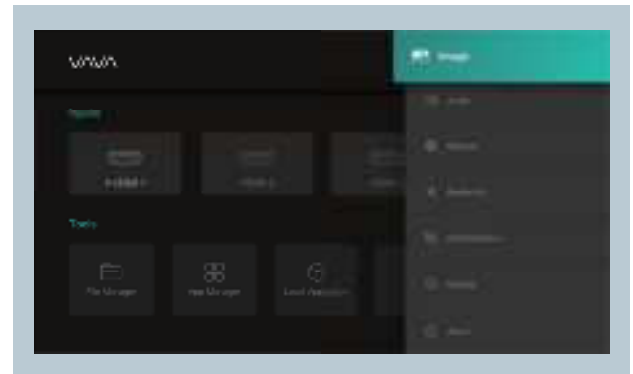

### 1) Image Settings

You can select the image mode or adjust the brightness, contrast, chroma, hue and definition.

### 2) Advanced Settings

You can select the MEMC mode or adjust the dynamic contrast, color temperature, refresh rate or reset to factory settings.

### 3) Light Source Settings

You can select the light source mode or adjust the light source brightness.

### 4) Keystone Correction

You can adjust the image.



### 5) Electric Focus

You can adjust the focus by the Left/Right button on the remote to get the clearest projection.

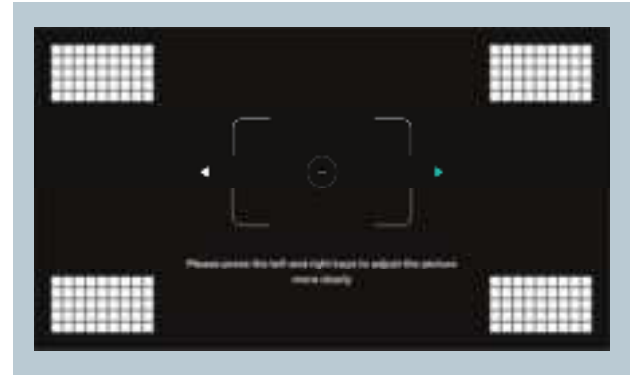

## 11. PLAYBACK SETTINGS

When playing videos, press the Menu button to prompt a sidebar menu which includes the followings: Video ratio, Sound track, Subtitle, Playback settings, Cycle mode, and Audio Effect.

## 12. ALEXA VOICE CONTROL

1. Press the voice assistant button on the remote control to activate Alexa.
2. Say "Alexa" with voice command to control and explore your laser TV.

\*You can also control other smart devices connected to Alexa, such as smart LED lamps, smart home cams etc.

## 13. MOUSE MODE

Go to Settings -> General -> Mouse Mode -> On/Off to enter/exit Mouse mode.

While in Mouse mode, you can use the remote as a computer mouse as to control the projector with greater flexibility.



# CLEANING AND MAINTENANCE

# 3

- Before cleaning, unplug the power cord from the socket. Wipe the exterior of the projector routinely with the provided cleaning cloth or a cloth designed for professional use. Do not apply abrasive detergent, solvent or other coarse chemicals to avoid scrapes.
- Leave plenty of space around the vents for heat dissipation.
- Do not place anything blocking the speaker for better sound.
- Disassembling the device will not only null the warranty but may also cause harm to your or others' safety.
- Do not use the projector near water, sources of heat, high-voltage electrical wires, or sources of magnetic fields.
- If you use the projector in a country other than where you purchased it, use the correct power cord for that country.
- Do not block the lens during projection using a book or any other object. This could damage the projector or cause a fire.
- Remove the battery from the remote control if not in use for extended amounts of time in case of leakage and damage to the remote.
- Please follow local regulations to promptly and properly dispose of used batteries.



# TROUBLE- SHOOTING

# 4

**Q: Do I need to prepare a screen for projection?**

**A:** For optimal performance, project onto a flat wall with only one color, preferably white. However, using a recommended screen can provide the best experience.

**Q: The motion detection is not working.**

**A:** Make sure the sensor is not blocked and the function is active in Settings.

**Q: The remote control isn't working.**

- A:**
- Press any button on the remote, if blue light flashes, the remote is still powered.
  - Check if there're obstacles in front of the VAVA icon on the projector. If the remote can't work while pointing to the VAVA icon, the remote or the infrared function is abnormal.
  - If the infrared function is good, check if the remote has been paired via Bluetooth.

**Q: I can't play files from my USB drive.**

**A:** Your USB drive may be in a format that the projector does not support. Back up the files to your computer, reformat the USB drive, transfer the files back to the drive, and plug the drive into the projector to try again.

**Q: I've connected a device via the HDMI port, but there's still no signal.**

**A:** There are 3 HDMI ports on the projector. Make sure the device is connected to the correct one, the HDMI wire is working, and the HDMI device is powered on.

**Q: No sound is playing.**

**A:** Check whether the correct audio output (built-in speaker/external speaker) is selected in Audio Settings, or if it's muted.



**Q: The image isn't clear/there is no image.**

- A:**
- Make sure the original video is in high definition.
  - Check that the projector is in focus: go to Settings -> Image -> Electric Focus to adjust accordingly.
  - Power off the device and unplug the power cord. Plug it again after 1 min and power on the device.

**Q: How do I choose the audio output?**

- A:** When connecting to a speaker in Settings, there are two output options: PCM and RAW.
- For PCM output, the audio source is decoded. It is compatible with almost all speaker types, but the sound quality may be compromised.
  - For RAW output, no decoding is involved for the audio output, thus retaining the original sound (as long as the connected speaker supports the decoded audio). RAW output is generally the optimal choice.

**Q: What do I do if the system breaks down or gets stuck?**

- A:**
- Power off the device and unplug the power cord. Plug it in again after 1 min and power on the device.
  - There may be too much on the system cache. Free up space on Android and delete rarely-used apps.
  - There may be a network problem. Check whether your network supports watching videos online. A bandwidth of 8M or higher can usually support 1080p videos.

**Q: The remote control got disconnected / I can't power on the device wirelessly because the remote isn't paired.**

- A:** The projector can only be powered on by pressing the power button on the projector or via infrared. Powering on via Bluetooth is not available.

**Q: The system prompts a message of high temperature and the device shuts off automatically.**

- A:** Make sure the device is working in a proper ambient temperature (within the device's working temperature range) and that the vents are not blocked. Restart the device.

**Q: The device cannot be powered on.**

- A:** Check whether the device is connected to power properly and that the socket connects to electricity. Press the Power button on the device to start.

**Q: How do I use the projector with Alexa Voice Control?**

- A:**
- Press the voice assistant button on the remote control to activate Alexa.
  - Try with any voice command as required, e.g. Alexa, turn off the VAVA projector.

**Q: How do I use the remote in mouse mode?**

- A:**
- Go to Settings -> General -> Mouse Mode -> On/Off to enter mouse mode.  
Then you can use the remote as a mouse to control the projector.
  - Go to Settings -> General -> Mouse Mode -> On/Off to exit mouse mode.

The troubleshooting guide addresses the most common problems. If problems persist, feel free to contact the Customer Support at [support@vava.com](mailto:support@vava.com).

## WARRANTY AND SERVICE

Rev\_1.1-EN

We will provide you with after-sales service based on specific local policies. Please contact your local sales representative or after-sales team for more details. If you have any questions, please feel free to reach us via email at [support@vava.com](mailto:support@vava.com).



[www.vava.com](http://www.vava.com)

### **NORTH AMERICA**

E-mail: [support@vava.com](mailto:support@vava.com)

### **MANUFACTURER**

Manufacturer: Shenzhen NearbyExpress Technology Development Co.,Ltd.  
Address: Floor 7, Building E, Galaxy World Phase II, Shenzhen, China

**Made in China**

NOTE: This equipment has been tested and found to comply with the limits for a Class B digital device, pursuant to part 15 of the FCC Rules. These limits are designed to provide reasonable protection against harmful interference in a residential installation. This equipment generates uses and can radiate radio frequency energy and, if not installed and used in accordance with the instructions, may cause harmful interference to radio communications. However, there is no guarantee that interference will not occur in a particular installation. If this equipment does cause harmful interference to radio or television reception, which can be determined by turning the equipment off and on, the user is encouraged to try to correct the interference by one or more of the following measures:

- Reorient or relocate the receiving antenna.
- Increase the separation between the equipment and receiver.
- Connect the equipment into an outlet on a circuit different from that to which the receiver is connected.
- Consult the dealer or an experienced radio/TV technician for help

Changes or modifications not expressly approved by the party responsible for compliance could void the user's authority to operate the equipment.

This device complies with Part 15 of the FCC Rules. Operation is subject to the following two conditions:

(1) this device may not cause harmful interference, and (2) this device must accept any interference received, including interference that may cause undesired operation.

RF Exposure Warning Statements for Laser Projector:

This equipment complies with FCC radiation exposure limits set forth for an uncontrolled environment. This equipment shall be installed and operated with minimum distance 20cm between the radiator & body.

This device contains licence-exempt transmitter(s)/receiver(s) that comply with Innovation, Science and Economic Development Canada's licence-exempt RSS(s). Operation is subject to the following two conditions:

- (1) This device may not cause interference.
- (2) This device must accept any interference, including interference that may cause undesired operation of the device.

L'émetteur/récepteur exempt de licence contenu dans le présent appareil est conforme aux CNR d'Innovation, Sciences et Développement économique Canada applicables aux appareils radio exempts de licence. L'exploitation est autorisée aux deux conditions suivantes :

- (1) L'appareil ne doit pas produire de brouillage;
- (2) L'appareil doit accepter tout brouillage radioélectrique subi, même si le brouillage est susceptible d'en compromettre le fonctionnement.

IC Radio Frequency Exposure Statement for Laser Projector:

The device has been evaluated to meet general RF exposure requirements. The device can be used in mobile exposure conditions. The min separation distance is 20cm.

IC Déclaration d'exposition aux radiofréquences pour pour projecteur laser :  
L'appareil a été évalué pour répondre aux exigences générales en matière d'exposition aux RF. L'appareil peut être utilisé dans des conditions d'exposition mobiles. La distance de séparation minimale est de 20cm.

Operation of this device is restricted to indoor use only. (W52 band)

Le fonctionnement de cet appareil est limité à une utilisation en intérieur uniquement. (W52 band)