

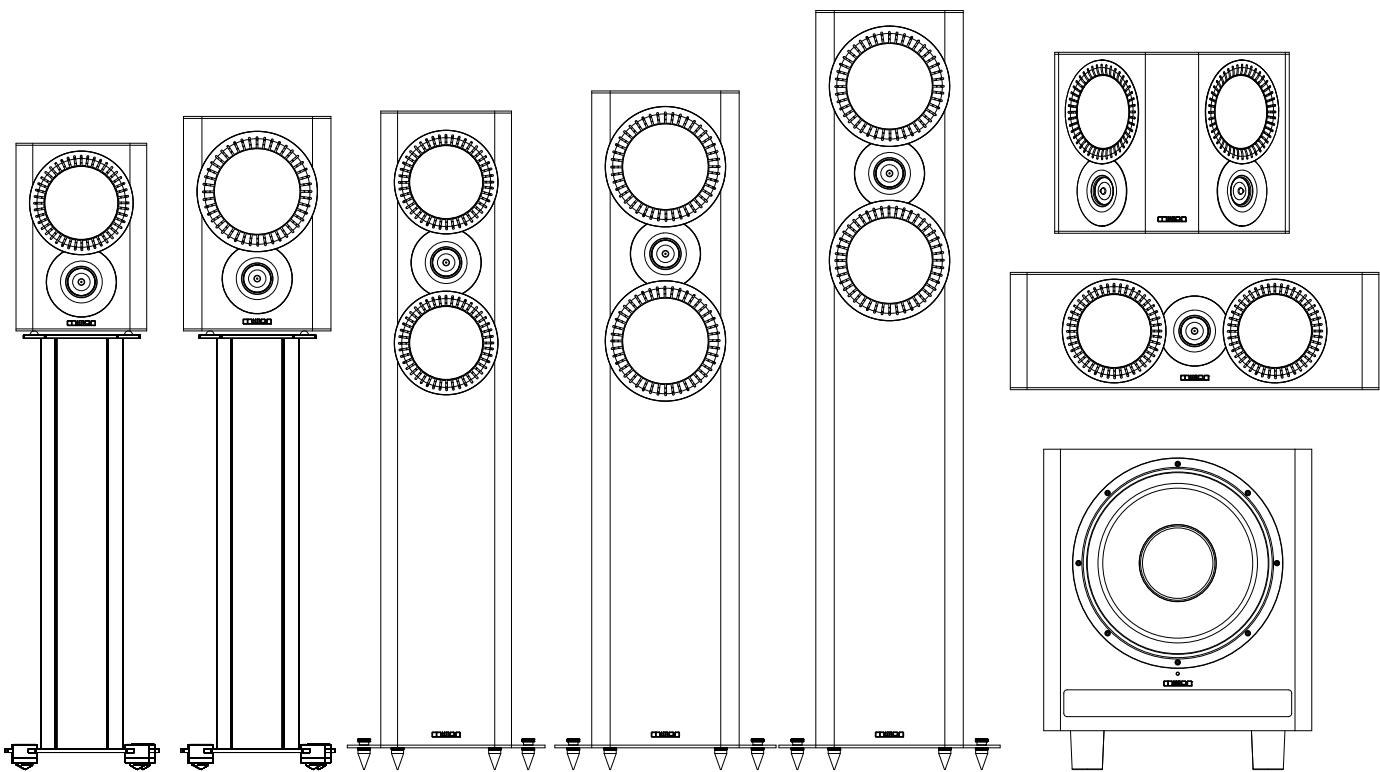

QX-1
 QX-2
 QX-3
 QX-4
 QX-5
 QX-C
 QX-S
 QX-12SUB



User's Manual

MISSION



IMPORTANT SAFETY INSTRUCTIONS



This symbol indicates that there are important operating and maintenance instructions in the literature accompanying this unit.



This symbol indicates that dangerous that dangerous voltage constituting a risk of electric shock is present within this unit.

WARNING: TO REDUCE THE RISK OF FIRE OR ELECTRIC SHOCK, DO NOT EXPOSE THIS APPARATUS TO RAIN OR MOISTURE.

Read these instructions.

Keep these instructions.

Heed all warnings.

Follow all instructions.

DO NOT use this apparatus near water.

Clean only with a dry cloth.

DO NOT install near any heat sources such as radiators, heat registers, stoves, or other apparatus (including amplifiers) that produce heat.

Protect the power cord from being walked on or pinched particularly at plugs, convenience receptacles, and the point where they exit from the apparatus.

Unplug this apparatus during lightning storms or when unused for long periods of time.

Refer all servicing to qualified service personnel. Servicing is required when the apparatus has been damaged in any way, such as the power-supply cord or plug is damaged, liquid has been spilled or objects have fallen into the apparatus, the apparatus has been exposed to rain or moisture, does not operate normally, or has been dropped.

Install in accordance with the manufacturer's instructions.

WARNING: If using spikes make sure that they do not pierce mains cables etc under / above the carpet.

When making any connections, switch the amplifier off.

When you switch on your system or change sources, set the volume control at minimum and turn the level up gradually.

DO NOT use your amplifier at full volume.

Avoid extreme settings of tone controls or graphic equalisers.

DO NOT place heavy objects on top of loudspeaker cabinets.

Ensure that all loudspeakers in the system are correctly wired and are in phase.

Do not connect your loudspeakers to the mains supply, except for subwoofers.

DO NOT attempt to dismantle the loudspeaker. There are no user serviceable parts inside and you will render the warranty void.

Site hi-fi electronics away from the loudspeakers on a rigid stand or cabinet.

Loudspeakers should not be placed directly facing other hi-fi units, or share the same shelf or cabinet.

Site unscreened speakers and subwoofers at least 0.5m away from TV sets, computers etc. Some manufacturers forbid the placing of objects ontop of their TV sets. Check your TV handbook before installing the centre speaker directly on your TV sets. Consult your TV dealer if you are in any doubt.

Use only attachments / accessories specified by the manufacturer.

DO NOT subject loudspeakers to excessive cold, heat, humidity or sunlight.

DO NOT block any ventilation openings.

DO NOT defeat the safety purpose of the polarized or grounding-type plug. A polarized plug has two blades with one wider than the other. A grounding type plug has two blades and a third grounding prong. The wide blade or the third prong are provided for your safety. If the provided plug does not fit into your outlet, consult an electrician for replacement of the obsolete outlet.

The apparatus must not be exposed to dripping or splashing objects filled with liquids, such as vases, should be placed on the apparatus.



Use only with a card, stand, tripod, bracket or table specified by the manufacturer, or sold with the apparatus. When a card is used, use caution when moving the cart / apparatus combination to avoid injury from tip-over.

CAUTION: The mains power switch for electronic equipment should be located in an open area without any obstructions. The mains power plug must remain freely operable at all times.

CAUTION: Changes or modifications not expressly approved by the manufacturer could void the user's authority to operate this device.

	CAUTION! RISK OF ELECTRIC SHOCK DO NOT OPEN	
TO REDUCE THE RISK OF ELECTRIC SHOCK DO NOT REMOVE COVER (OR BACK) NO USER-REMOVEABLE PARTS INSIDE REFER SERVICING TO QUALIFIED PERSONNEL		
AVERTISSEMENT: RISQUE DE CHOC ELECTRIQUE- NE PAS OUVRIR		



WARNING: When an amplifier is driven beyond its power output capabilities it will produce output capabilities it will produce distorted results which will quickly damage your speakers by overheating. Make sure that your amplifier is not left unattended when playing, for example at parties, and turn the volume control down at the first sign of audible distortion,

Warranty Conditions

The warranty card enclosed should be completed and returned to Mission or its Distributor within 8 days of purchase.

No dealer or distributor may vary the terms of this warranty which is personal to the original purchaser and is not transferable.

Please retain the sales receipt as proof of purchase.

Warranty claims must wherever possible be made through the Dealer from whom the equipment was purchased.

This warranty excludes:

Damage caused through neglect, accident, misuse, wear and tear, or through incorrect installation, adjustment or repair by unauthorised personnel. Any unauthorised servicing will result in loss of warranty.

Liability for damage or loss occurring in the transit to or from the purchaser.

Consequent damage, loss or injury, arising from or in conjunction with this equipment.

Equipment for attention under warranty should be considered return carriage paid. If equipment is found to comply with the published specification, Mission reserves the right to raise a charge.

The above conditions do not affect your statutory rights as a consumer.



Welcome to Mission!

The QX Series is the latest in a long line of distinguished Mission loudspeakers. These technologically advanced loudspeakers will complement the finest electronics and décor. This series incorporates purpose - designed bass driver cones, precision engineered motor systems and advanced tweeters. All our loudspeaker drive units are manufactured in our factory using the latest precision tooling. High quality binding posts feature on all models. Your Mission QX speakers will bring you great pleasure for many years.

General Information

Please read these instructions carefully before installing your loudspeakers. A few minutes studying this manual will ensure a superb performance from your loudspeaker for many years. Please attention to all cautions printed on the pages marked with this symbol



Preparing Your Loudspeakers

The Mission QX-3, QX-4 and QX-5 floorstanding models require fitting with the included plinth and spikes before use. Use the screw provided to secure the plinths to the base of the speakers. Make sure that the screws are fully tightened.

After unpacking, the other loudspeakers need no further preparation.

Preparing the Floorstanding Loudspeakers (QX-3, QX-4, QX-5)

ATTACHING THE SPIKES

CAUTION: SPIKES ARE SHARP.

Make sure that there are no wires or hidden obstacles that could be damaged by the spikes in the immediate operational area of the speakers.

NEVER drag a loudspeaker on its spikes. always lift it. If the item is heavy get assistance.

A mounting hole is located at each corner of the plinth. Thread a spike through each hole.

Tighten the collar finger tight so that the spike is secure but not locked in place.

After all the spikes are attached, invert the loudspeaker and place it carefully on the floor.

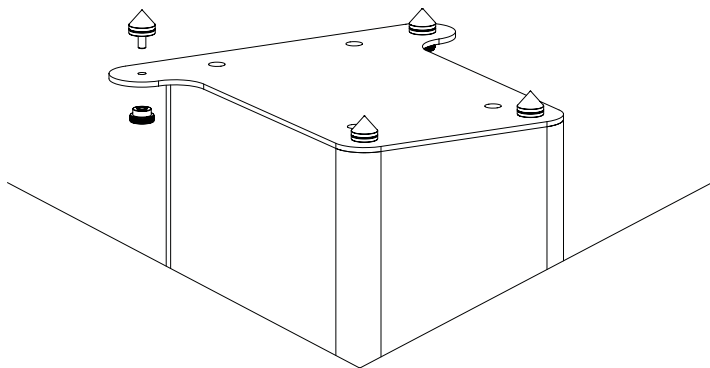

Connecting your loudspeakers

Conventional Loudspeaker Connections

Loudspeaker cable is polarity coded along one edge. Split the cable to a depth of about 25mm and strip 8mm of insulation from each wire. If the cable is stranded, twist the strand together.

Terminal Panels

Your loudspeakers use two or four terminals. When single wiring speakers use the connecting links as shown opposite. Unscrew the terminal. Thread the bare end of the cable through the cross-hole ensuring there are no loose strands. Tighten securely. Connect the red, positive (+) terminal of the left loudspeaker to the corresponding red, positive (+) amplifier terminal. Connect the black, negative (-) terminals similarly. Repeat for the right channel.

Bi-Wiring

All floorspeaker models in the Mission QX Series can be bi-wired for improved performance.

Remove both pairs of shorting links and connect a cable to each pair of terminals, running them to a common connection at the amplifier output terminals.

In the figure to the right, the terminal panel on the left is bi-wired; the panel on the right is conventionally wired. Note the shorting links.

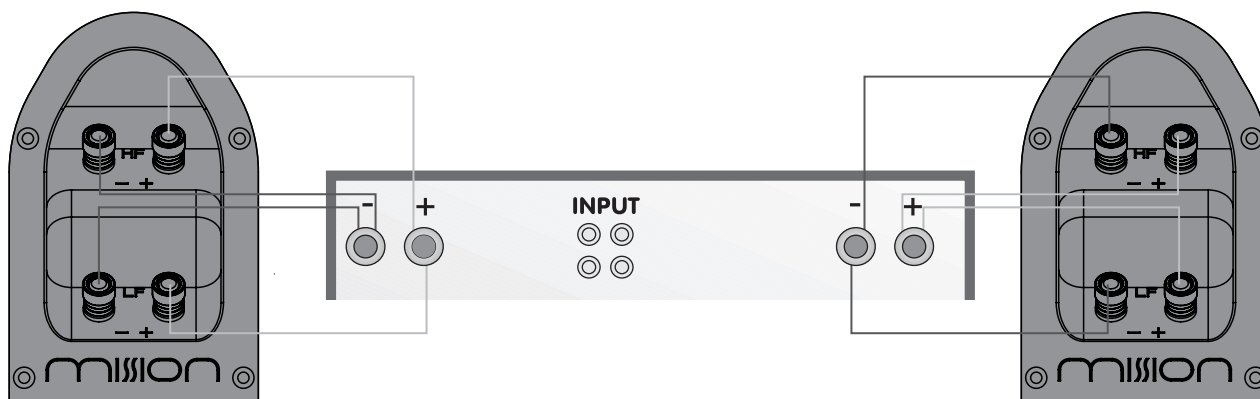

Bi-Amping

By using separate amplifiers for LF and HF drive units you can further improve performance. This is known as bi-amping. Note that the amplifier inputs are linked.

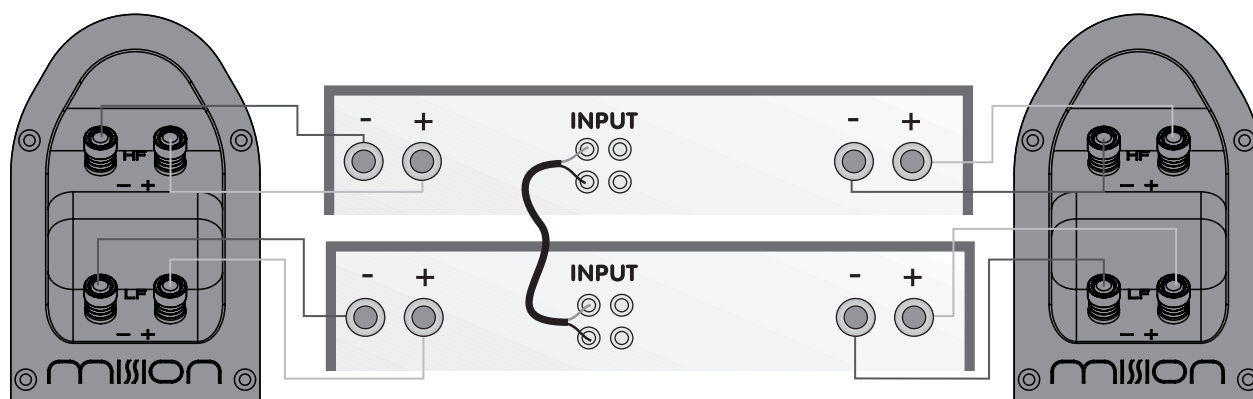

Positioning Your Loudspeakers

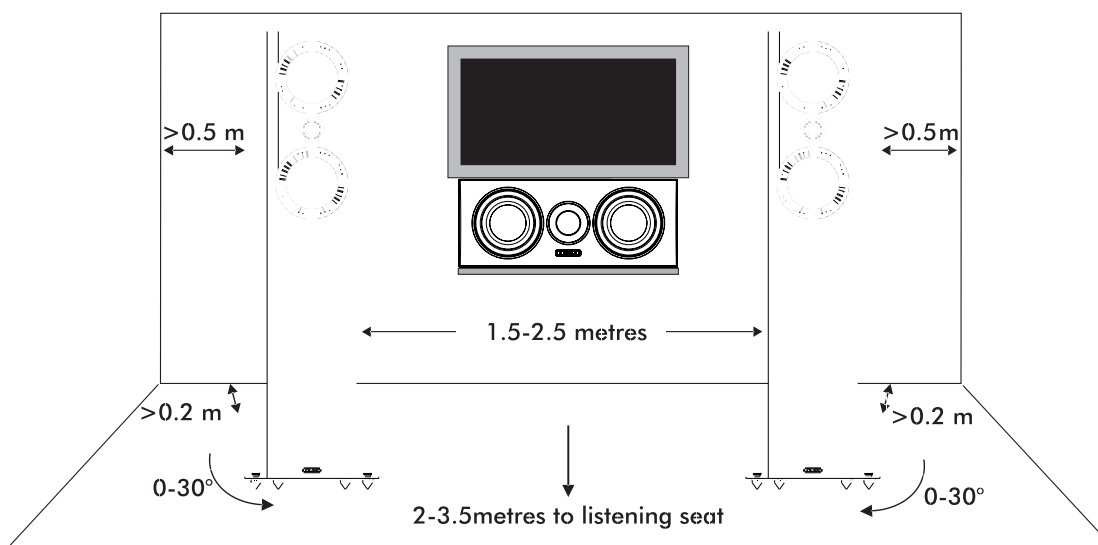

Floor Standing and Bookshelf Loudspeakers

Mission QX-3, QX-4 and QX-5 loudspeakers should be placed on the floor (ideally on spikes). Mission QX-1 and QX-2 should be mounted on rigid stands, ideally spike coupled to the floor.

Height is important: A stand should place the top of a speaker at ear level to a seated listener. Shelf or bracket mounting is second best. The distance from the wall can profoundly affect loudspeakers' sonic performance. If your speakers are too close to the wall the bass will boom and sound will be coloured. Moving them into the room may increase clarity but tends to reduce the bass output. When positioned correctly, the high frequency response is smooth with well-defined, powerful bass. Start with the speakers about 300mm from the wall and 1.8m apart. The distance from each loudspeaker to the side wall should be at least 500mm. Vary the distance between the two loudspeakers and the distance from the wall until you get a perfect stereo stage. If your loudspeakers are wired correctly, the sound should be full with a clean treble and a deep, rich bass.

Centre and surround speaker

Your QX-C centre loudspeakers should be positioned ontop of the TV monitor or on a shelf in a console below the TV set. If you place the unit directly on top of the TV, ensure that the cabinet can stand the weight and the assembly is stable. Place the stand on a stable surface and place the QX-C on the stand. Ensure the stand is central to the speaker cabinet. Check your TV handbook or consult your TV dealer if you are in any doubt.

The surround speakers should be placed above head height and behind the listening seat. They may be stand or bracket mounted on the side walls or on the rear walls but always behind the listener. Do not operate them within 450mm of a TV screen.

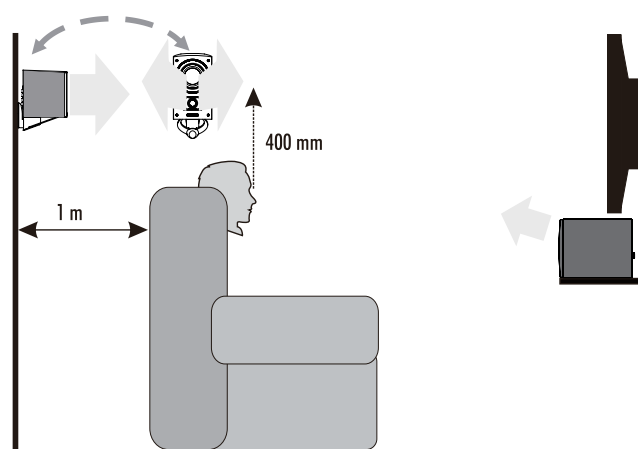

Tuning and Phase

Phase: To check the loudspeaker phase, check the polarity of your speaker wire at the terminals of the loudspeakers and at the loudspeaker terminals of the amplifier. The conductor colour should always be connected the same way round. If your loudspeakers are connected correctly, you will hear a full sound with clean midrange and a deep, powerful bass.

Positioning Surround Loudspeakers

QX-S Surround Loudspeakers

The speakers should ideally be sited 600 mm-1.5 metres above the listening position and 2.5-3.5 metres apart, central to the listener and behind the listening position, preferably on a rear wall. If the listening position is some distance from a rear wall, the speakers may be mounted on opposite side walls but always behind the listening position.

Ensure that the wall is sound and can support the product. Drill two 5mm holes in the wall 180mm apart. Fix a suitable No 8 round head screw firmly into each hole using appropriate wall plugs. Leave a stub of 5mm protruding from the wall.

Connect the loudspeakers. Align the holes in the mounting brackets over the screw and carefully lower the unit onto the screws. The speaker should now be securely attached with the spacers resting against the wall. Now connect the speakers to the amplifier.

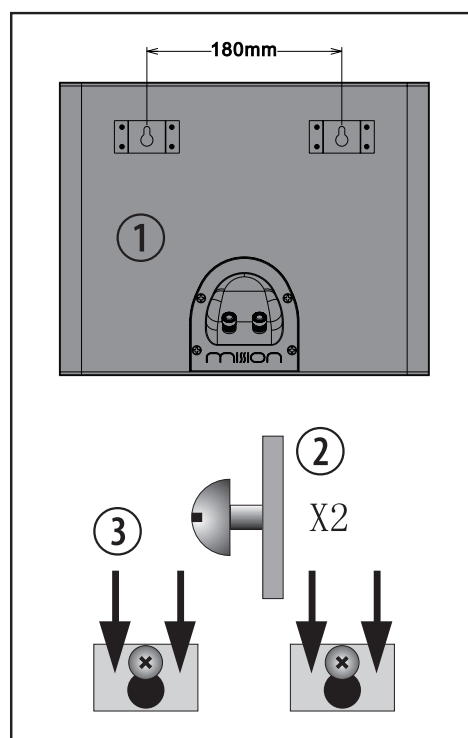

5.1 System connections

The front left and front right channels are bi-wired to provide the best fidelity.

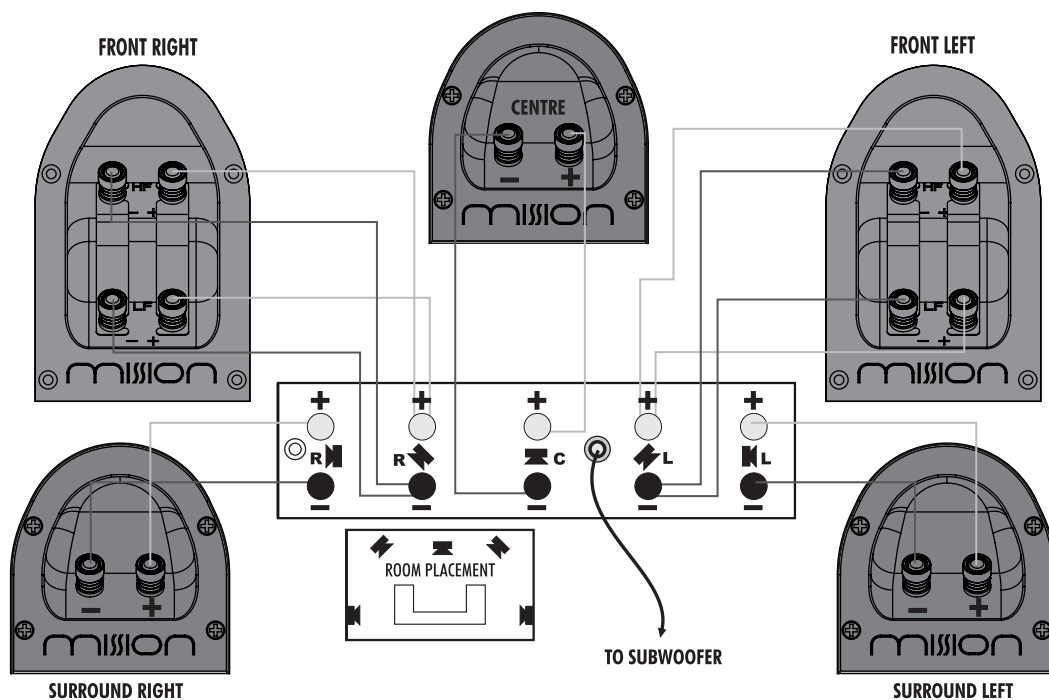

Setting Speaker Sizes

When used with a subwoofer, digital AV processors usually require you to set the size of the loudspeakers for good bass management. This is usually 'Large' or 'Small'. With the exception of the QX-1 and QX-2 all the loudspeakers should set to 'Large'. Depending on the performance of your subwoofer you may set the QX-3 to 'Large' or 'Small'.

Loudspeaker maintenance

Use a cloth to clean your cabinet and very occasionally a slightly damped cloth to remove finger marks, etc. Although the grilles may be removed, these speakers

have been voiced to sound at their best with grilles on. We do not advocate removal of the grilles: if necessary clean the grilles carefully in place with a soft brush.

Home Theatre Topics

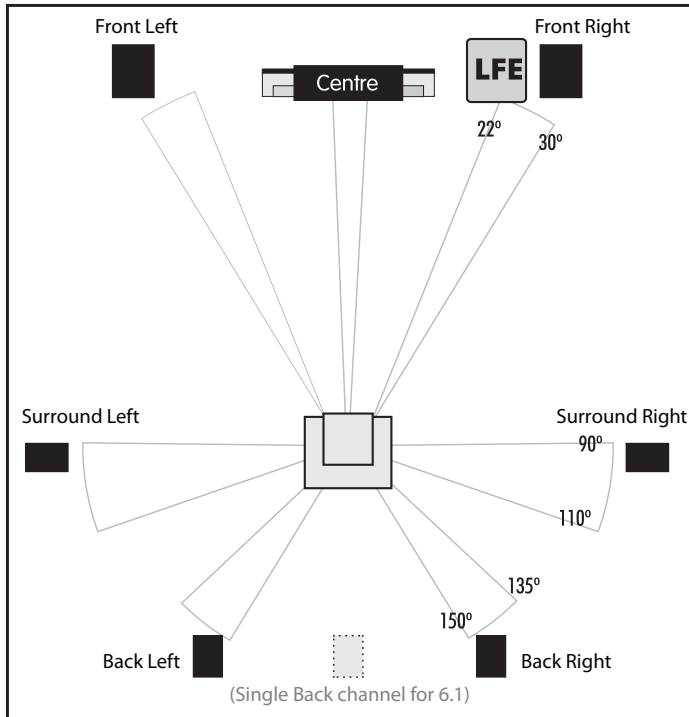

Loudspeaker Positioning

Front Loudspeakers: The front loudspeakers are placed on either side of the TV monitor, 2 to 3 metres apart. The speakers should be angled slightly so they are aimed towards the listeners.

Rear Surround Channels

We recommend placing the surround speaker in a high position, behind the listeners head. If the rear wall is more than 1 metre behind the listening seat, an alternative position is on the side walls. If the walls are a long way from the listening seat, consider stand mounting the loudspeakers.

Centre Channel

Most of the dialogue comes from the centre loudspeaker. Speech should appear to originate from the actors mouths. Operating height is important. Ideally the front and centre channel speakers should be at the same height. The front of the cabinet should be level with the TV screen.

CONNECTING THE SUBWOOFER TO THE SYSTEM

Control Panel of the QX-12SUB Subwoofer

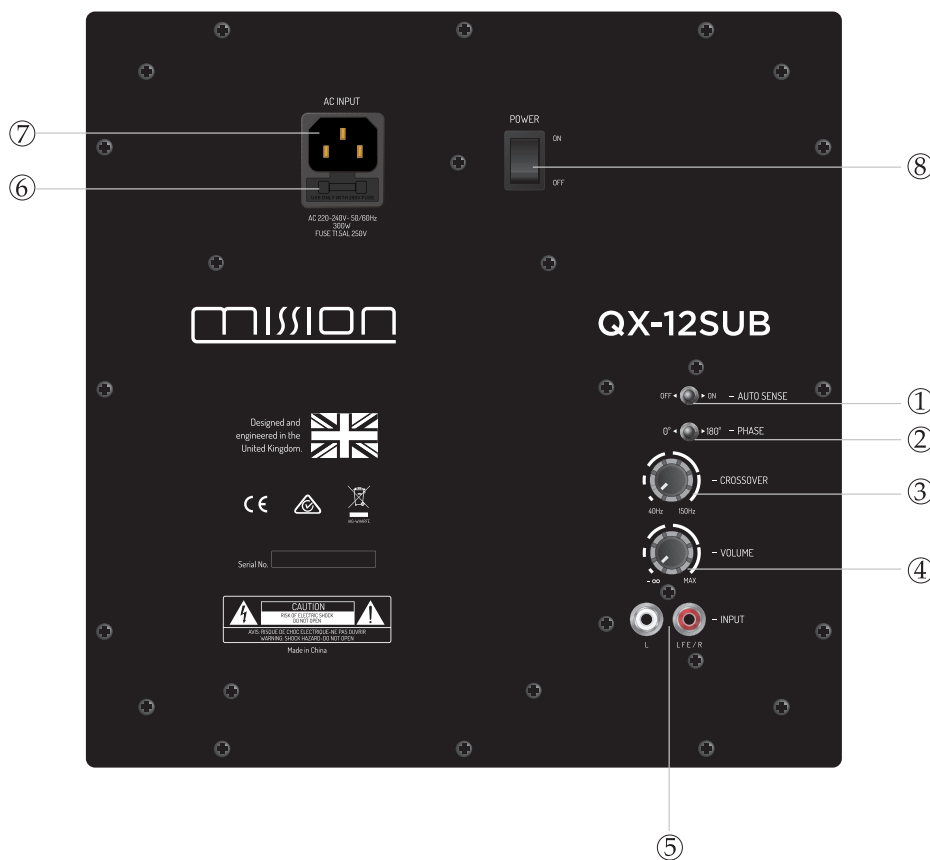

- | | |
|-------------------------------|------------------------------|
| 1 Auto Sense Switch | 5 Line Level Input/LFE Input |
| 2 Phase Switch | 6 Mains Power Fuse |
| 3 Crossover Frequency Control | 7 IEC Mains Input Socket |
| 4 Volume Control | 8 Mains Power Switch |

A/V Processor Connections

Your subwoofer has been designed for optimum performance with a digital processor. If your A/V processor has a line level or LFE subwoofer output you should use this connection. You will need to purchase a single screened RCA phono lead from your dealer. Connect this lead to the LFE input of the subwoofer as shown.

Alternatively, you may use a split mono lead from the processor to Line Inputs of the subwoofer. In this case the input level at the subwoofer will be slightly higher.

Stereo Line Output Connections

If your amplifier has a spare preamplifier output or a stereo subwoofer output, connect the subwoofer as shown. You will need a stereo screened RCA phono cable.

Pre Out - Main in Connections

If you use a stereo pre and power amplifier, or an amplifier where the pre and main amplifier can be separated, connect the subwoofer as shown. There are two alternative methods.

You will need two screened RCA 'Y' adaptors and two single RCA phono cables.

Remove the Pre-Main links on your amplifier. Connect the socket (common) of an RCA 'Y' adaptor to the Left Channel Pre Out socket on the amplifier and the other leg to the Left Channel Main In socket. Connect the remaining plug on this combination to the Left Channel Line Level input on the subwoofer. Repeat this for the Right Channel.

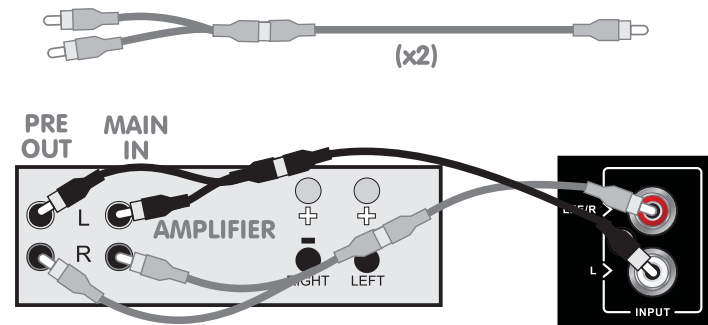
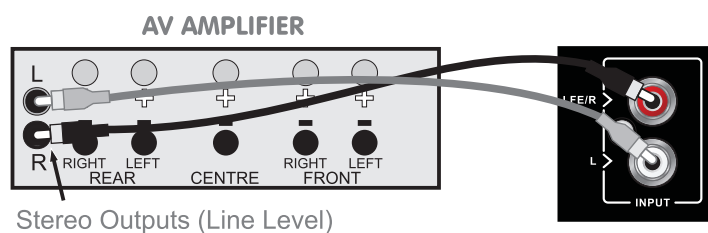
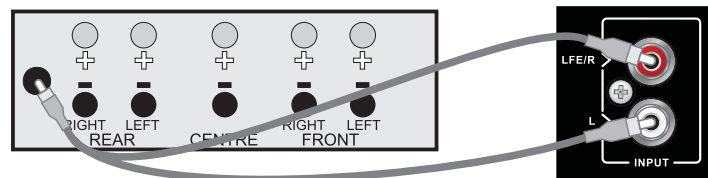
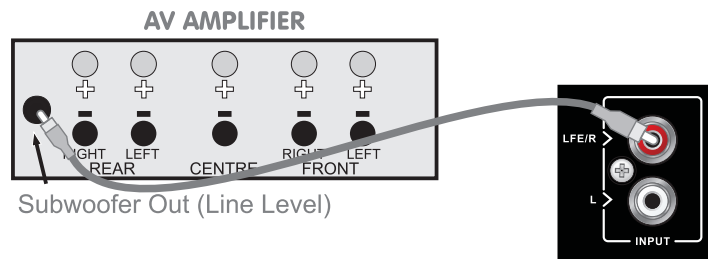



OPERATING YOUR SUBWOOFER

Check that all connections to the subwoofer have been properly made and that the main volume control is at minimum. Plug the supplied power cord into the mains socket on the rear panel.

Initial Settings

Volume Control: Set the subwoofer volume control to the minimum before proceeding.

Crossover Control: Adjust frequency to integrate QX-12SUB subwoofer with your system requirement.

Phase Switch: The Phase switch should be initially set to 0°.

Switching On

Plug in the mains plug and switch the power on. Now switch the subwoofer on with the rest of your system.

When switched on, the power indicator light will glow and the subwoofer will be operational.

Basic Tuning

Volume Setting: Play a programme with extended bass and set the system volume to a resonal level. Adjust the subwoofer volume control to produce the desired level of bass. The bass should be even and an extension of the main loudspeakers. Do not set the control too high or you will swamp the sound with too much bass and clarity and definition will suffer.

Phase Switch: If the bass is indistinct or lacks depth, the Phase switch may need adjustment. Set the switch to 0° and listen carefully to some music with extended bass. If there is insufficient bass output from the subwoofer set the Phase switch to 180°. Select the position which produces the most natural, extended bass.

Crossover Adjustment: This adjusts the blend between the subwoofer and the main speakers and enables the system to be set up for optimum bass performance. The higher settings are for use with small bookshelf loudspeakers, the lower setting for large floorstanding models. If you choose too low a setting with small speakers, there will be a 'hole' in the bass response; too high a setting with large speakers will result in the upper bass becoming bloated. Again the subwoofer should be an extension of the main loudspeakers.

Auto-Sense Switch: This feature reduces the power consumption when there is no music signal. When the Auto-Sense Switch is on, the amplifier will be activated immediately once an audio signal is detected at the inputs, and it will turn into the mute status when no signal is detected for about 20 minutes, which lowers the power consumption. This feature can be made invalid by setting this switch to off.

Mains Operation

When the system is not in use for extended periods, we suggest you switch off the subwoofer to protect it from switching noises caused by domestic appliances, etc. The best practice is to switch the complete system on and off from a central point. Bear in mind that if you play the system with the subwoofer switched off you will get no bass!

Always turn the main volume control to minimum when you switch the system on or off.



Specification

Model

	QX-1	QX-2
General description	2-way bookshelf speaker	2-way bookshelf speaker
Design philosophy and core technology		
Enclosure type	bass reflex	bass reflex
Transducer complement	2-way	2-way
ABR		
Bass driver	5"(135mm) Long Fiber Composite Cone	6.5"(165mm) Long Fiber Composite Cone
Midrange driver		
Treble driver	1.5"(38mm) Textile Ring Dome	1.5"(38mm) Textile Ring Dome
Full-range driver		
AV shield	No	No
Sensitivity (2.0V @ 1m)	87dB	88dB
Recommended amplifier power	25-100W	25-120W
Peak power handling		
Peak SPL	95dB	95dB
Nominal impedance	4Ω (Compatible 8Ω)	4Ω (Compatible 8Ω)
Minimum impedance	3.9Ω	3.6Ω
Frequency response(+/-3dB)	55Hz ~ 24kHz	44Hz ~ 24kHz
Bass extension(-6dB)	48	38Hz
Crossover frequency	2.4kHz	2.2kHz
Cabinet Volume (in litres)	8.1L	13.5L
Dimensions (mm)		
Height (on plinth)	280mm	320mm
Width	195mm	220mm
Depth (with terminals)	(250+10)mm	(300+10)mm
Carton size	520*345*380mm	570*395*420mm
Net weight	6.2kg/pcs	8.5kg/pcs
Gross weight	14.2kg/ctn	19.0kg/ctn

Model

	QX-3	QX-4
General description	2-way floorstanding speaker	2-way floorstanding speaker
Design philosophy and core technology		
Enclosure type	bass reflex	bass reflex
Transducer complement		
ABR		
Bass driver	5"(135mm) Long Fiber Composite Cone x2	6.5"(165mm) Long Fiber Composite Cone x2
Midrange driver		
Treble driver	1.5"(38mm) Textile Ring Dome	1.5"(38mm) Textile Ring Dome
Full-range driver		
AV shield	No	No
Sensitivity (2.0V @ 1m)	88dB	88dB
Recommended amplifier power	25-120W	25-150W
Peak power handling		
Peak SPL	95dB	95dB
Nominal impedance	4Ω (Compatible 8Ω)	4Ω (Compatible 8Ω)
Minimum impedance	3.8Ω	3.8Ω
Frequency response(+/-3dB)	42Hz ~ 24kHz	36Hz ~ 24kHz
Bass extension(-6dB)	36Hz	32Hz
Crossover frequency	2.0kHz	2.2kHz
Cabinet Volume (in litres)	35L	48L
Dimensions (mm)		
Height (on plinth)	(950+20)mm	(980+20)mm
Width	195mm	220mm
Depth (with terminals)	(300+10)mm	(335+10)mm
Carton size	435*325*1100mm	470*350*1130mm
Net weight	20.0kg/pcs	23.8kg/pcs
Gross weight	23kg/ctn	27.4kg/ctn

Specification

Model

General description

Design philosophy and core technology

Enclosure type

Transducer complement

ABR

Bass driver

Midrange driver

Treble driver

Full-range driver

AV shield

Sensitivity (2.0V @ 1m)

Recommended amplifier power

Peak power handling

Peak SPL

Nominal impedance

Minimum impedance

Frequency response(+/-3dB)

Bass extension(-6dB)

Crossover frequency

Cabinet Volume (in litres)

Dimensions (mm)

Height (on plinth)

Width

Depth (with terminals)

Carton size

Net weight

Gross weight

QX-5

3-way floorstanding speaker

bass reflex

`

12"(300mm) cone long-throw x1

6.5"(165mm) Long Fiber Composite Cone x2

1.5"(38mm) Textile Ring Dome

No

90dB

30-200W

96dB

4Ω (Compatible 8Ω)

3.5Ω

32Hz ~ 24kHz

27Hz

180Hz,1.8kHz

16L/48L

(1100+20)mm

220mm

(400+10)mm

535*350*1250mm

34kg/pcs

38.0kg/ctn

QX-C

2-way centre speaker

bass reflex

2-way

5"(135mm) Long Fiber Composite Cone X2

1.5"(38mm) Textile Ring Dome

No

88dB

25-120W

95dB

4Ω (Compatible 8Ω)

3.9Ω

58Hz ~ 24kHz

50Hz

1.6kHz

8.1L

175mm

550mm

(170+10)mm

640*265*280mm

8.6kg/pcs

9.7kg/ctn

Model

General description

Design philosophy and core technology

Enclosure type

Transducer complement

ABR

Bass driver

Midrange driver

Treble driver

Full-range driver

AV shield

Sensitivity (2.0V @ 1m)

Recommended amplifier power

Peak power handling

Peak SPL

Nominal impedance

Minimum impedance

Frequency response(+/-3dB)

Bass extension(-6dB)

Crossover frequency

Cabinet Volume (in litres)

Dimensions (mm)

Height (on plinth)

Width

Depth (with terminals)

Carton size

Net weight

Gross weight

QX-S

2-way surround speaker

closed-box system

2-way

5"(135mm) Long Fiber Composite Cone X2

1.5"(38mm) Textile Ring Dome X2

No

88dB

25-120W

95dB

4Ω (Compatible 8Ω)

3.9Ω

110Hz ~ 24kHz

90Hz

1.8kHz

7.2L

270mm

350mm

(180+5)mm

415*415*370mm

6.5kg/pcs

15.2kg/ctn



Specification

Model	QX-12SUB
Description/Format	Active Dynamic-Drive IB subwoofer system
Drive Units	1 x (12")300mm cone long-throw
Frequency Response	35- 120Hz \pm 3dB
Amplifier Power Output	300W
Peak Power Output	450W
Line Input Sensitivity	200mv for maximum output
Crossover Range	30 - 150Hz
Inputs	Stereo Line In (2 x RCA Phono) Mono (LFE) Line In (RCA Phono)
Input Impedance	Line Input 10k Ω LFE 5k Ω
Signal-to-noise ratio (S/N)	\geq 85dB
Avg. Max Output @1m	118dB
Features	Phase inversion, Auto on-off
Dimensions	Height: (420+58)mm(with feet) Width: 400mm Depth: (450+15)mm "
Net weight	23.0kg
Accessories	IEC power cord









IAG House, 13/14 Glebe Road, Huntingdon, Cambridgeshire, PE29 7DL, UK
Tel: +44(0)1480 452561 Fax: +44(0)1480 413403 www.mission.co.uk
IAG reserves the right to alter the design and specifications without notice. All rights reserved © IAG Group Ltd.
Mission is a member of the International Audio Group. CODE: MH14-MNL005a

